

## GT6-225AG 6V225Ah/C20



AG(AGM and Gel) range uses the advanced GEL design, which combines the best features of both AGM and GEL construction into one battery line, and the purity fumed silica to form sulfuric acid thixotropic Gel, and fills the batteries with vacuum to ensure complete penetration of electrolyte through separators and plates pastes.

This range battery is designed to meet the requirement of frequent cyclic and high temperature application such as boardband, PVs etc.

### Applications

- Broadband
- Electric Powered Vehicle
- UPS
- Photovoltaic & Solar System
- Electric Powered Toy
- Control System
- Vacuum Cleaner
- Medical Equipment
- Golf Cars and Buggies
- Wheel Chairs

### General Features

- Ideal for cyclic uses
- Good tolerance to higher temperature applications.
- ABS containers and covers(UL94HB, UL94V-0) optional.
- Safety valve installation for explosion proof.
- Higher safety & reliable construction.
- Extra durability and deep cycle ability for heavy demand applications.
- Low self discharge characteristic.
- Good tolerance to higher temperature applications.

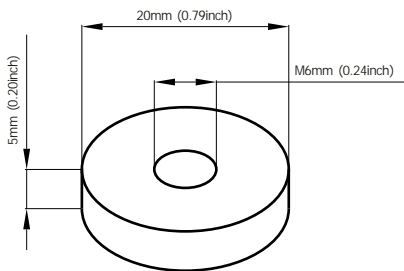

**Standard Terminal Dimensions**  
(Optional terminal please check terminal information page)

### Construction

- Component .....Raw material
- Positive .....Lead dioxide
- Negative .....Lead
- Container .....ABS
- Cover .....ABS
- Sealant .....Epoxy Resin
- Safety valve .....EPDR
- Terminal .....Copper
- Separator .....AGM
- Electrolyte .....sulfuric acid thixotropic Gel

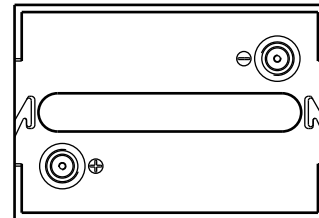
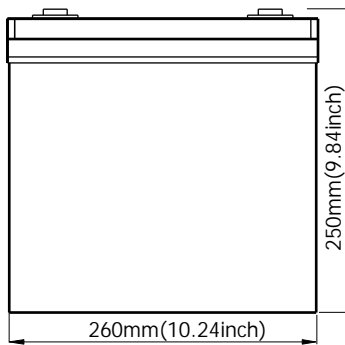

Battery Model	GT6-225AG			
Designed Life	12 Years (Floating) or > 750 Cycles @ 50% D.O.D			
Capacity(25°C)	20HR(11.25A,1.75V)	10HR(20A,1.75V)	5HR(37.5A,1.75V)	1HR(132A,1.75V)
	225Ah	200Ah	187.5Ah	132Ah
Dimensions	Length	Width	Height	Total Height
	260mm(10.2inch)	180mm(7.09inch)	245mm(9.65inch)	250mm(9.84inch)
Approx. Weight	33.6Kg (74.4 lbs)			
Internal Resistance	Full charged at 25°C: 0.0032 Ohm			
Self Discharge	3% of capacity declined per month at (25°C)			
Capacity Affected by Temp.(20HR)	40°C	25°C	0°C	-15°C
	102%	100%	85%	65%
Charge Voltage(25°C)	Cycle use		Float use	
	7.2-7.5V(-15mV/ °C), max. Current: 55A		6.8-6.9V(-10mV/ °C)	

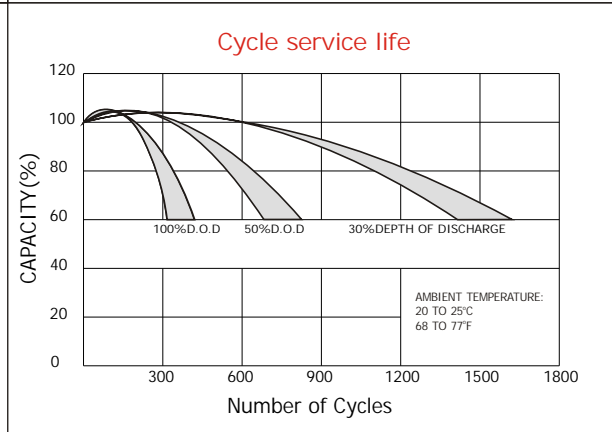
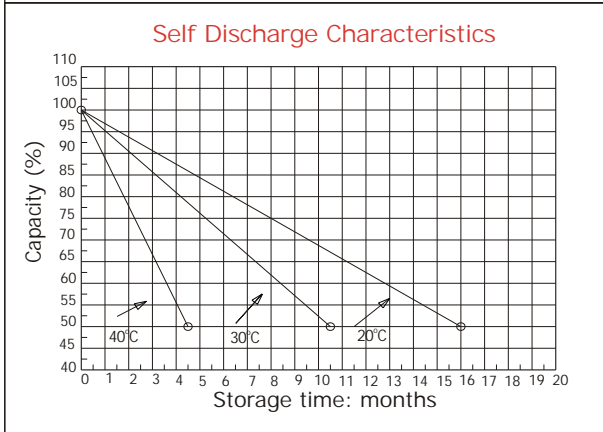
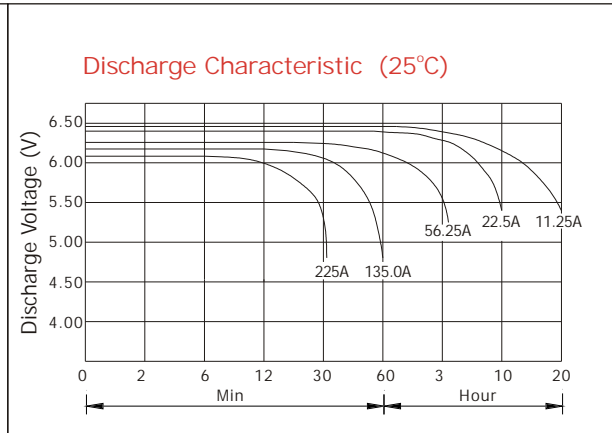
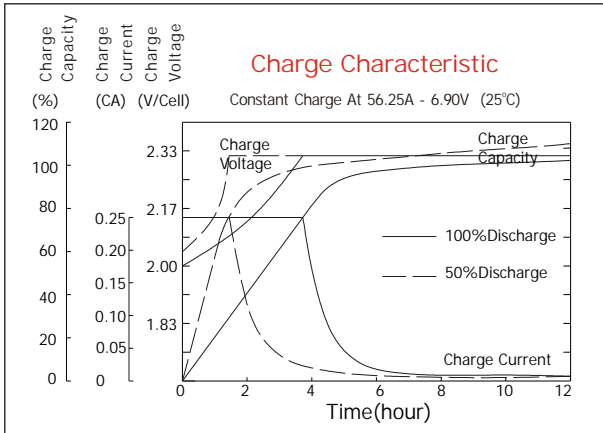

### Constant current discharge ratings-amperes at 25°C

F. V/Time	5MIN	10MIN	15MIN	30MIN	1HR	3HR	5HR	10HR	20HR
1.60V	788	540	394	236	149	61.4	42.9	23.9	11.9
1.67V	709	493	383	230	148	61.2	42.6	23.5	11.8
1.70V	673	475	369	225	148	61.2	42.6	23.3	11.8
1.75V	599	439	349	221	146	60.8	42.2	22.9	11.8
1.80V	540	407	333	214	144	60.5	41.9	22.5	11.3
1.85V	410	335	288	197	143	60.3	41.5	22.1	10.7

### Constant power discharge ratings-watts at 25°C

F. V/Time	5MIN	10MIN	15MIN	30MIN	1HR	3HR	5HR	10HR	20HR
1.60V	1298	896	698	446	293	118	82.1	47.7	23.7
1.67V	1231	884	691	437	283	118	82.1	47.0	23.6
1.70V	1150	862	680	425	275	118	82.1	46.6	23.6
1.75V	1071	806	639	414	273	116	81.2	45.8	23.5
1.80V	961	749	601	403	268	115	79.9	45.0	22.7
1.85V	770	621	524	369	266	114	78.8	44.2	21.3

