

### GASTON GT

range is the most common standard and the first generation delicate product which is designed with AGM(Absorbent Glass Mat) technology, high performance plates and electrolyte. The definition of GT is coming from General purpose. Therefore, this range product has possessed various applications for common power backup system.

### Applications

- |                           |  |
|---------------------------|--|
| Alarm System              | Medical Equipment                      |
| Cable Television          | UPS                                    |
| Communication Equipment   | Power Tool                             |
| Control Equipment         | Emergency Power System                 |
| Security System           | Stand-by Electric Power Control System |
| Emergency Lighting System |  |

### General Features

- Sealed and maintenance free operation.
- Non-Spillable construction design.
- ABS containers and covers(UL94HB, UL94V-0) optional.
- Safety valve installation for explosion proof.
- High quality and high reliability.
- Exceptional deep discharge recovery performance.
- Low self discharge characteristic.
- Flexibility design for multiple install positions.

### Construction

- |           |                   |              |                    |
|-----------|-------------------|--------------|--------------------|
| Component | .....Raw material | Sealant      | .....Epoxy Resin   |
| Positive  | .....Lead dioxide | Safety valve | .....EPDR          |
| Negative  | .....Lead         | Terminal     | .....Lead          |
| Container | .....ABS          | Separator    | .....Fiber glass   |
| Cover     | .....ABS          | Electrolyte  | .....Sulfuric acid |

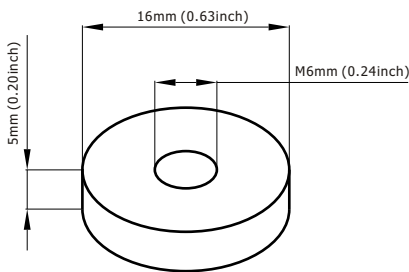

**Standard Terminal Dimensions**  
(Optional terminal please check terminal information page)

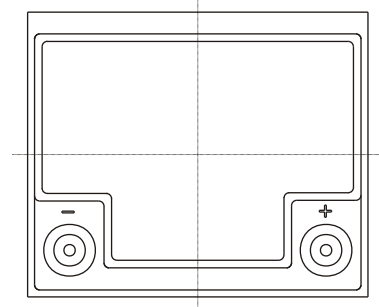
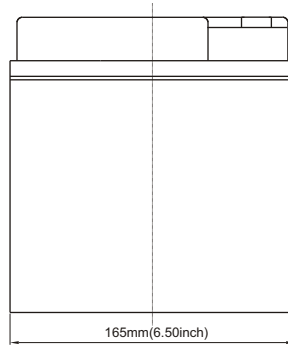
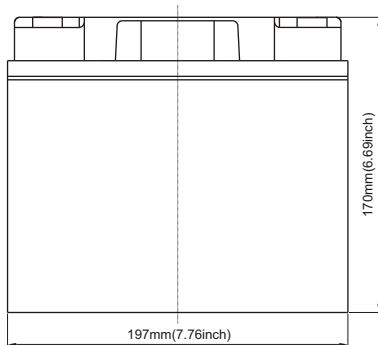

Battery Model	GT 12-38			
Designed Floating Life	8 Years			
Capacity(25°C)	20HR(1.9A,1.75V)	10HR(3.7A,1.75V)	5HR(6.7A,1.75V)	1HR(24A,1.75V)
	38Ah	37Ah	33.5Ah	24Ah
Dimensions	Length	Width	Height	Total Height
	197mm(7.76inch)	165mm(6.50inch)	171mm(6.73inch)	171mm(6.73inch)
Approx. Weight	12.7Kg (30.2 lbs)			
Internal Resistance	Full charged at 25°C: 0.0095 Ohm			
Self Discharge	3% of capacity declined per month at (25°C)			
Capacity Affected by Temp.(20HR)	40°C	25°C	0°C	-15°C
	102%	100%	85%	65%
Charge Voltage(25°C)	Cycle use		Float use	
	14.4-15V(-30mV/ °C), max. Current: 10A		13.6-13.8V(-20mV/ °C)	

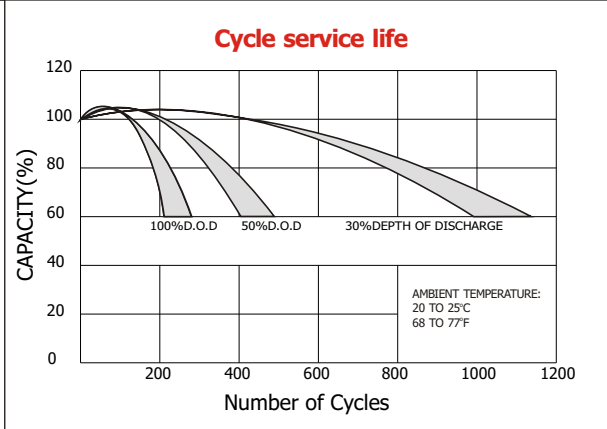
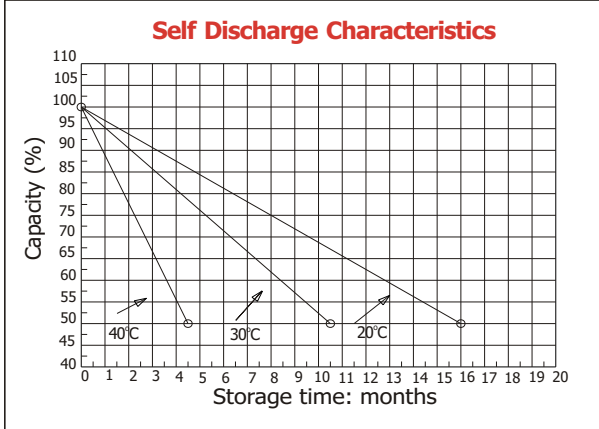
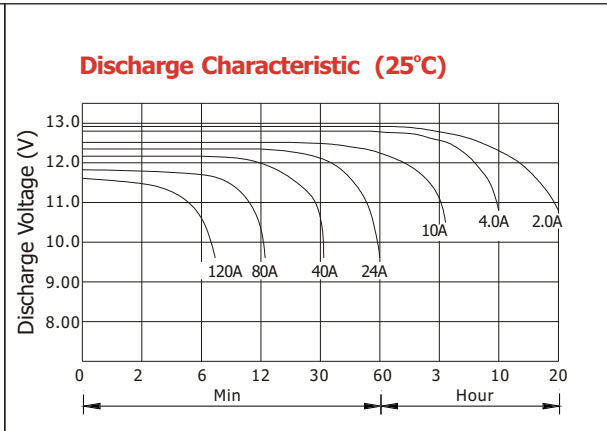
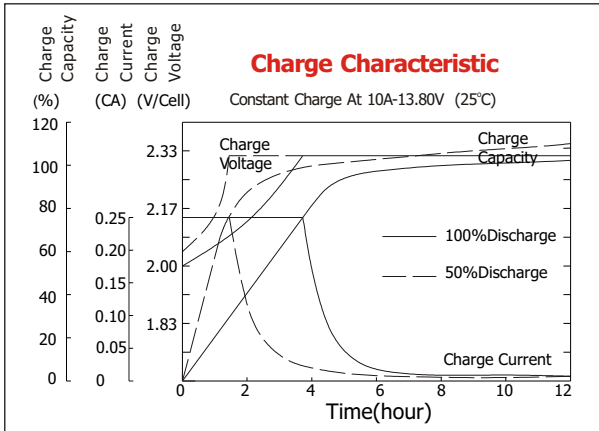

**Constant current discharge ratings-amperes at 25°C**

F.V/Time	5MIN	10MIN	15MIN	30MIN	1H-R	3H-R	5H-R	8H-R	10H-R	20H-R
1.60V	133	91.2	66.5	39.9	25.1	10.4	7.25	4.78	4.03	2.00
1.6V	120	83.2	64.6	38.8	25.0	10.3	7.19	4.73	3.97	2.00
1.70V	114	80.2	62.3	38.0	25.0	10.3	7.19	4.71	3.94	2.00
1.75V	101	74.1	58.9	37.2	24.7	10.3	7.13	4.65	3.87	1.99
1.80V	91.2	68.8	56.2	36.1	24.4	10.2	7.07	4.59	3.80	1.92
1.85V	69.2	56.6	48.6	33.2	24.1	10.2	7.02	4.53	3.74	1.80

**Constant power discharge ratings-watts at 25°C**

F.V/Time	5MIN	10MIN	15MIN	30MIN	1H-R	3H-R	5H-R	8H-R	10H-R	20H-R
1.60V	219	151	118	75.2	49.4	19.9	13.9	9.37	8.06	4.01
1.6V	208	149	117	73.7	47.8	19.9	13.9	9.30	7.94	3.99
1.70V	194	146	115	71.8	46.5	19.9	13.9	9.26	7.88	3.99
1.75V	181	136	108	69.9	46.1	19.6	13.7	9.13	7.74	3.97
1.80V	162	127	101	68.0	45.3	19.3	13.5	8.97	7.61	3.83
1.85V	130	105	88.5	62.3	44.9	19.3	13.3	8.83	7.47	3.60

